

Wishing Well Hose Reel Assembly Instructions



Material List

- | | |
|--|--|
| $\frac{3}{4}$ " X 1 $\frac{1}{2}$ " - 55' | 1 $\frac{1}{2}$ " O.D. Gal. Steel Pipe - 14" |
| $\frac{3}{4}$ " X 2 $\frac{1}{2}$ " - 26' | 1 $\frac{1}{2}$ " I.D. ABS Pipe - 1" |
| $\frac{3}{4}$ " X 3 $\frac{1}{2}$ " - 4' | $\frac{7}{8}$ " dia. Dowell - 4" |
| $\frac{3}{4}$ " X 5 $\frac{1}{2}$ " - 13' | $\frac{3}{8}$ " Rebar - 6' |
| 1 $\frac{1}{2}$ " X 3 $\frac{1}{2}$ " - 8' | $\frac{3}{8}$ " Sisal Rope - 24" |
| $\frac{3}{4}$ " angle brackets - 2 ea. | Landscape tie - 6' |
| $\frac{1}{2}$ " Pipe Brackets - 2 ea. | |
| #8 Flat Head Wood Screws | |
| 1 $\frac{1}{4}$ " - 120 ea. 1 $\frac{3}{4}$ " - 16 ea. 2 $\frac{1}{2}$ " - 3 ea. | |
| $\frac{1}{4}$ " X $\frac{3}{4}$ " Carriage Bolt, Nut & Washer - 1 ea. | |
| $\frac{3}{4}$ " X #8 Sheet Metal Screws - 4 ea. | |
| 1 $\frac{1}{2}$ " Gal. Finishing Nails - 12 ea. | |
| 2 $\frac{1}{2}$ " Gal. Finishing Nails - 12 ea. | |
| Shingle Nails - 1 pkg. | |
| Cedar Shingles to cover 8 sq. feet | |
| $\frac{1}{2}$ " male hose thread adapter - 1 ea. | |
| $\frac{1}{2}$ " copper pipe - 17" | |
| $\frac{1}{2}$ " copper 90° elbows - 2 ea. | |
| brass quick coupler for hose | |

Step 1

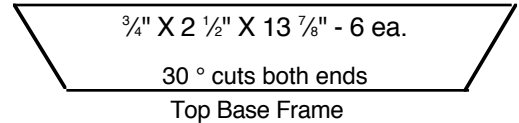
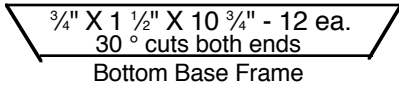

Cut the peices for the top and bottom frames and assemble lapping the joints as shown. Fasten each peice with three 1 $\frac{1}{4}$ " screws and waterproof glue, see note below.

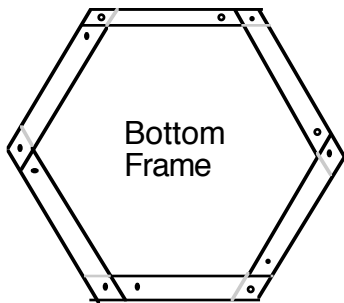
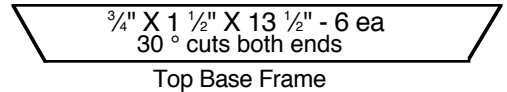

Note:
Use a spacer the thickness of the panel boards to determine distance "A", there may be a space where the narrow frame boards meet at "B". Dry assemble entire frame, then remove pieces one at a time and add glue.

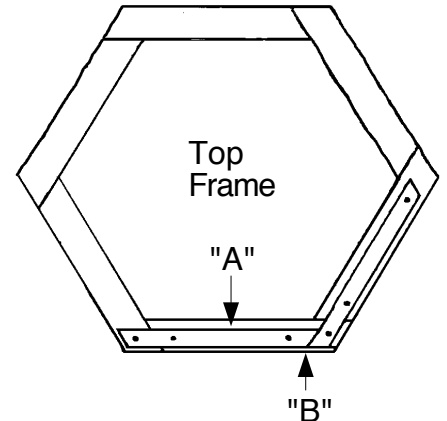

Step 2

Cut the six wide and twelve narrow panel boards, assemble the base by fastening panel boards to inside of top frame and outside of bottom frame with 1 $\frac{1}{4}$ " screws.

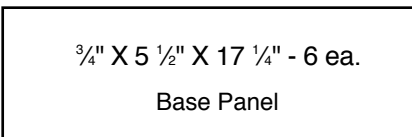
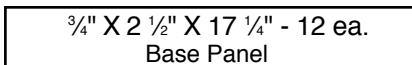
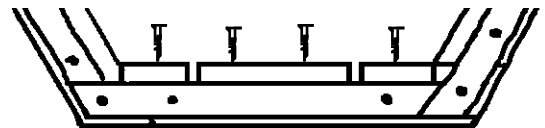

Step 3

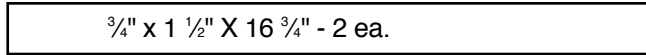
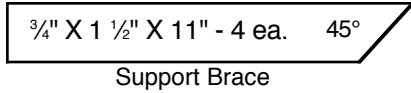
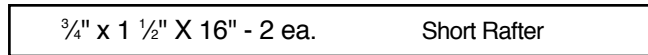
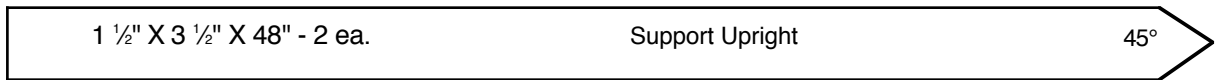

Cut the two uprights then drill holes 28" from the square end, one 1 1/2" and one 1 5/8" in diameter, then cut the four rafters and the four support braces. Using one long and one short rafter fasten them to the top of the uprights with 1 3/4" screws, repeat for the second one, then fasten the supports with 1 1/4" screws. Attach completed roof supports to base with 1 3/4" screws through wide panel boards.

Step 4 (Optional)

If you are making the roof planter attach two strips 19" long 6" from the top of uprights to hold the plant pot.

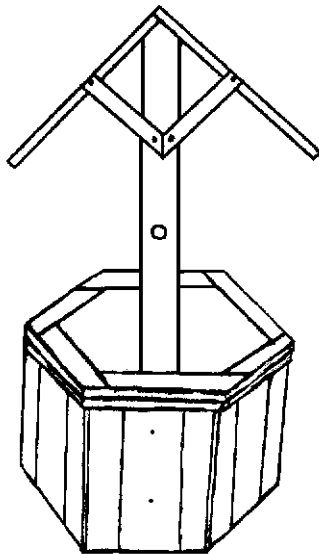
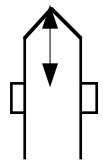

Step 5



Cut the eight roof slats and four gable trim boards, with 1 1/4" screws attach the roof slats spaced as shown, then attach trim boards with 1 3/4" screws.

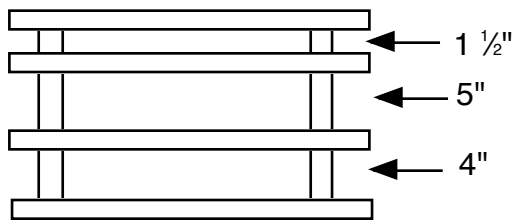
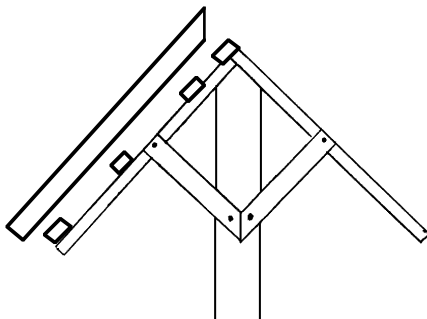

Step 6 (Omit and go to step 7 for roof planter)

Trim 6 1/2" off the butt of each shingle for the first row overhanging the bottom slat by 2" and the trim boards by 1/2" nailing into first slat. Lay a second layer covering the joints of the first layer nailing into second slat. Lay a second row cut to 13" long at the thin end spaced 6 1/2" from bottom nailing into third slat. Lay a third row 13" from bottom using the butts cut from first layer nailing into fourth slat. Trim the ridge with 3/8" thick lath.

Step 7 (Optional)

If you are making the roof planter cut 11" out of the center of the top two roof slats on each side, fasten the strips that have been removed to the fixed roof slats as shown with 1 1/4" screws. Trim 6 1/2" off the butt of each of the shingles in the first row, overhang the bottom slat by 2" and the trim board by 1/2" nailing into the bottom slat. Lay a second layer of shingles trimmed at the thin end to 13" long over the first covering the joints nailing into the second slat. Lay a second row of 13" long shingles on each side of opening nailing into third slat and 6 1/2" butts cut from first layer below opening spaced 6 1/2" from bottom. Lay a third row using remaining 6 1/2" butts on each side of opening 13" from bottom. Trim the ridge with lath or rip shingles as this is only a short span.

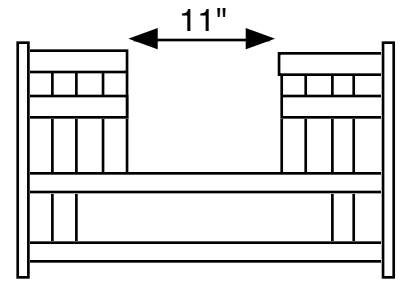

Step 8

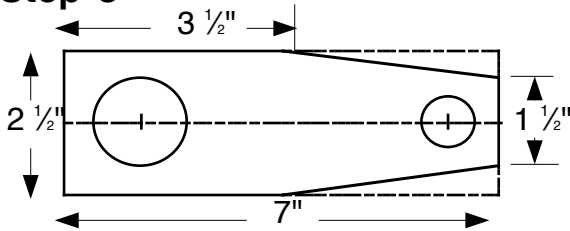

Cut crank arm from 3/4" material as shown above, round all four corners, drill 1 1/2" dia. hole 1 3/8" from large end and 7/8" dia. hole 3/4" from small end. Insert 4" long dowel in hole and fasten with glue and 1 1/4" long screw, drilling pilot hole for screw.

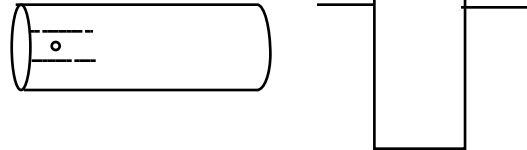

Cut 4 1/2" length of 1 1/2" pipe for short reel support. Drill two 3/16" dia holes 1/2" from end of pipe opposite each other. Cut two slots 1/2" apart 1 1/4" long, bend down to form tabs. Insert short end into 1 1/2" dia. hole in 2X4 upright and secure with two 1 1/4" screws.

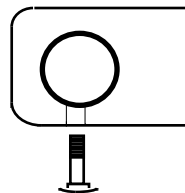

Cut 9 1/4" length of 1 1/2" dia. pipe, insert into hole in crank arm and drill 1/4" hole through arm and pipe, fasten with 1/4" X 1" carriage bolt and nut.

Step 9

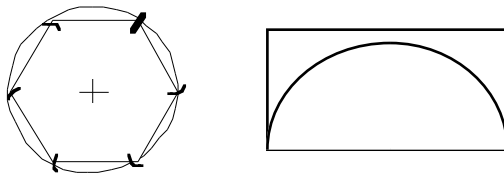

Using a compass set at 2 1/2" draw a 5" dia circle, mark off 2 1/2" arcs around circle to create hexagon on a sheet of paper. Using this as a pattern cut three hexagons from 1X6 x 3/4" material. Set compass at 5" and draw a circle 10" in dia. on sheet of paper. Fold in half to use as a pattern to cut four semi-circles from 1X6 X 3/4" stock.

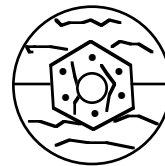

Make two spool ends by fastening a hexagon to two of the semi-circles alternating the direction of the grain using glue and wood screws. Drill a 1 1/2" hole in center of one and a 1 5/8" hole in center of other. Drill a 1 1/2" hole in center of remaining hexagon.



Cut two spacers 1/2" wide from 1 1/2" I.D. ABS pipe.

Step 10

Slide spacer on to stub, then spool end with 1 5/8" hole. Fasten angle brackets to hexagon on spool end and single hexagon even with the center holes with 3/4" X #8 sheet metal screw. Insert crank through other upright, slide on spacer, then spool side, then hexagon. Drill 1/8" pilot holes for #8 X 3/4" sheet metal screws to anchor angle brackets to pipe axel. Cut five 3/4" X 2 1/2" boards 12 3/4" long, attach these to the three hexagons with 1 1/4" screws leaving one side empty for hose to enter to connect to swivel.

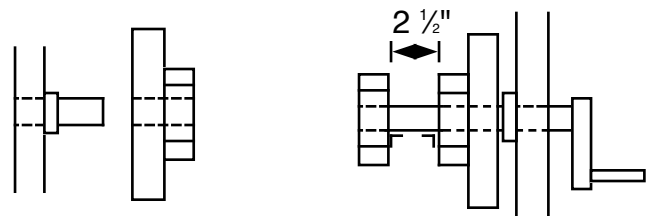

3/4" X 2 1/2" X 12 3/4" - 5 ea.

Mendoc Media ©

Wishing Well Hose Reel
Plan # 104

Step 11

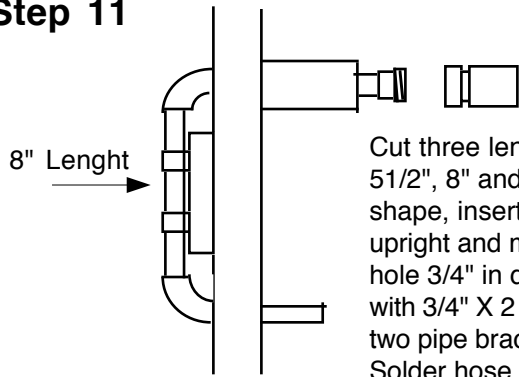

Cut three lengths of 1/2" copper pipe, 5 1/2", 8" and 3 1/2", solder into U shape, insert long end through hole in upright and mark position to drill second hole 3/4" in dia. Anchor pipe to upright with 3/4" X 2 1/2" X 6" spacer and the two pipe brackets with 1 1/4" screws. Solder hose thread adapter to top pipe and install quick coupler.

Water supply can be connected to bottom pipe directly with a reducer and a hose clamp, or an elbow can be soldered on, then a shut off tap can be plumbed in. The supply line can be buried by cutting into the sod between well and outside tap.

Cedar Bucket

Start with a 3/4" X 3 1/2" X 48" strip and bevel the sides at a 30° angle, cut four pieces 7" long and two 8 1/2" long. Shape the top of the 8 1/2" pieces as shown in fig. 1. With a compass measure the distance across the short edge of the boards, see fig. 2. Using this measurement draw a circle on a 3/4" X 5 1/2" X 5 1/2" piece, then with the same compass setting mark six arcs around the circumference of the circle, connect each arc with a line to form a hexagon as in fig. 3. Cut out the hexagon and with 1 1/2" galvanized finishing nails fasten the strips to the base and to each other as shown in fig. 4, making sure 8 1/2" strips are opposite each other.

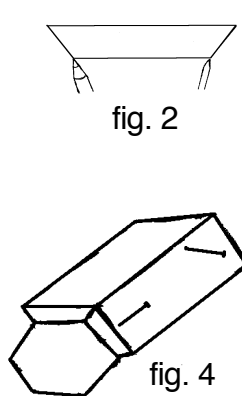
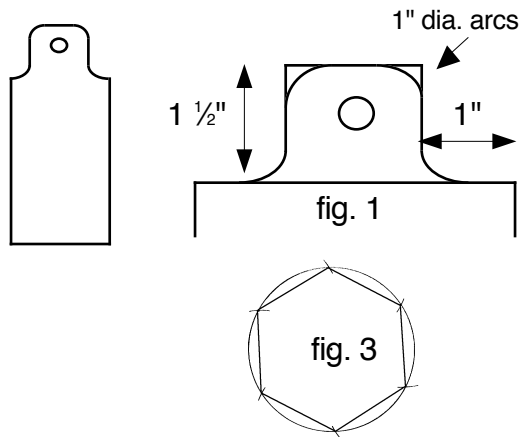

Step 12

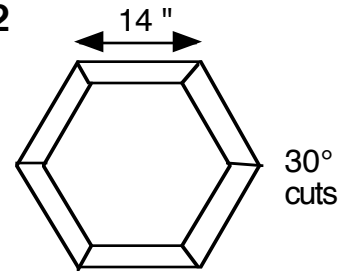

Make hexagon base using landscape ties, toenail sections together, drill 3/8" hole in center of every second side. Level base for well and drive 24" long lengths of rebar through holes to anchor base to ground. Fasten well to base with 2 1/2" long screws through bottom frame.

This is an alternative choice built around the black plastic containers that plants come in from nurseries and can be done without removing the plant.

Rip shingles to about 1 3/4" wide, cut them to the length of the pot. Plane the strips so they are tapered about a 1/4" at the thin end, this will depend on pot, and at an angle so they butt together, drill a hole in the strip and fasten it to outside of pot with a short screw, this is somewhat of a trial and error method as the last piece is just cut to fit into the last space. As an added touch black plastic strapping can be wrapped around the bucket to simulate metal hoops and fastened with the same short screws. Drill holes on opposite sides for rope handle if required.

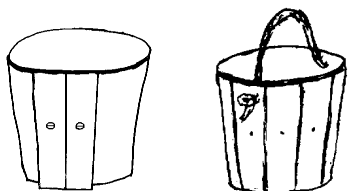

MendocMedia ©

Wishing Well Hose Reel
Plan # 104